

Article number: 0101065
 Description: Retaining ring A 48 DIN 471
 Spring steel
 Note: Fitted with ZGA pilers

Measures

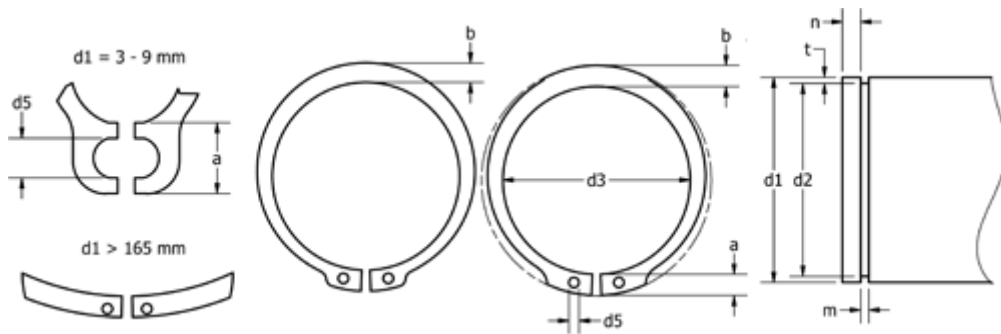

a max	= 6.9	FN kN	= 30.7	s	= 1.75
AN mm ²	= 184.0	FRg kN	= 9.55	t	= 1.25
b	= 5.0	FR kN	= 49.40	tol	= -0.25
d1	= 48	g	= 2.0	tol	= -0.06
d2	= 45.5	K kN-mm	= 90.00	tol	= +0,39-0,90
d3	= 44.5	m min	= 1.85	Tong	= ZGA-3
d5 min	= 2.5	n abl x 1000	= 10.0	Weight kg/1000	= 7.900
Description	= A48	Nominal drive	= 3.8		